

FEHLING...

... THE DIFFERENCE

5

NEEDLE HOLDERS

NADELHALTER

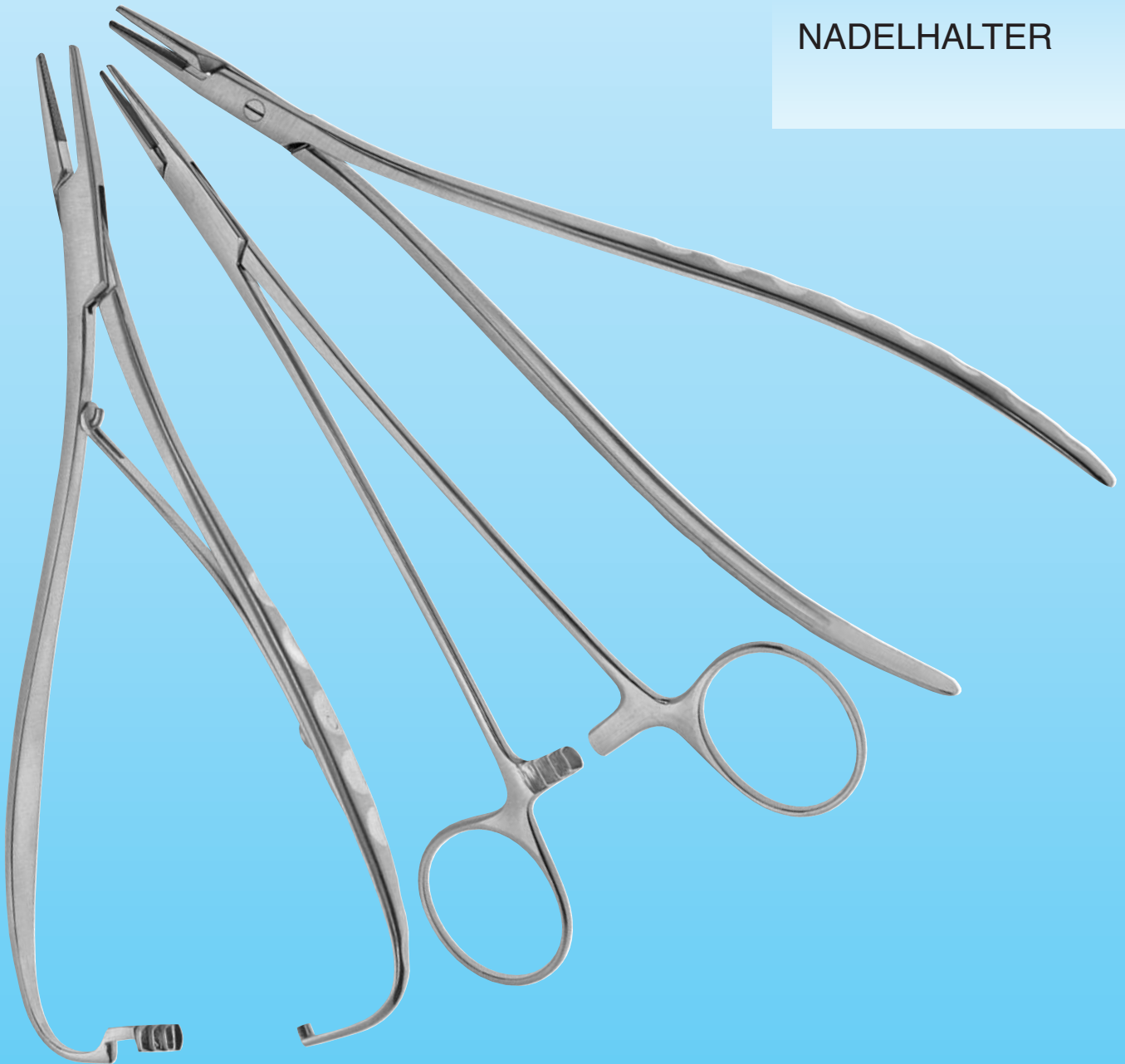

FEHLING
INSTRUMENTS

Hanauer Landstraße 7A · 63791 Karlstein/Germany · www.fehling-instruments.de



+49 (0) 61 88 - 95 74.40



+49 (0) 61 88 - 95 74.45



info@fehling-instruments.de



TCM
VASCULAR

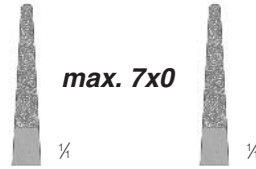

LENGTH LÄNGE	STEEL STAHL	TITANIUM TITAN
125 mm	KKA-1	KKB-1
145 mm	KKA-2	KKB-2
175 mm	KKA-3	KKB-3
200 mm	KKA-4	KKB-4
225 mm	KKA-5	KKB-5



1/2



PLASMA
MIKRO-RYDER



LENGTH LÄNGE	STRAIGHT GERADE	CURVED GEBOGEN
130 mm	KOR-0	
150 mm	KOR-2	
180 mm	KOR-4	KOR-5
200 mm	KOR-6	
230 mm	KOR-8	KOR-9

**PLEASE FIND MICRO NEEDLE HOLDERS IN CATALOGUE No. 1
MIKRONADELHALTER FINDEN SIE IN KATALOG Nr. 1**



PLASMA
EUPHRATE

max. 5x0



LENGTH LÄNGE	STRAIGHT GERADE
150 mm	KKD-1
175 mm	KKD-2
200 mm	KKD-3
230 mm	KKD-4

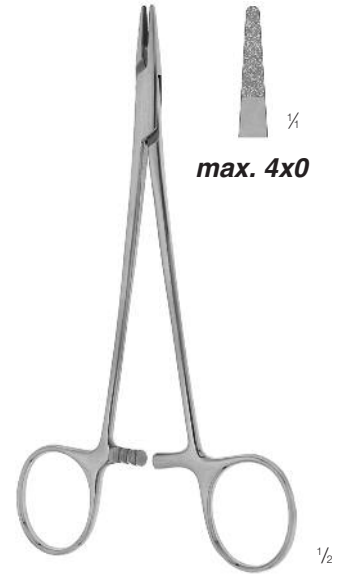

PLASMA
CRILE

150 mm
KOH-3

max. 4x0

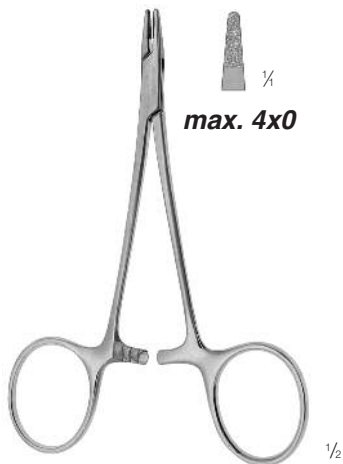

PLASMA
DERF

120 mm
KOH-6

max. 4x0



PLASMA
HALSEY

130 mm
KOH-2

max. 4x0

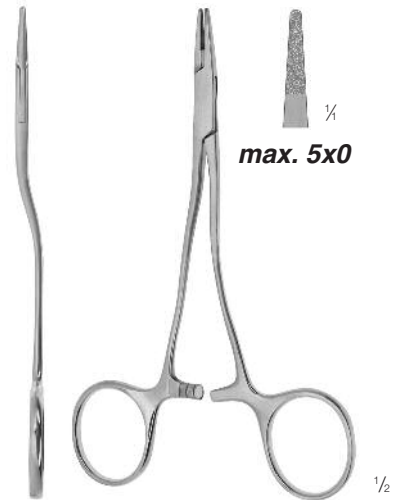

PLASMA
KILNER

135 mm
KOH-4

max. 5x0





DE BAKEY

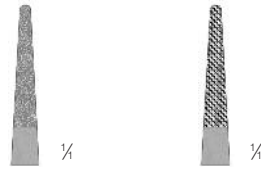

LENGTH LÄNGE	PLASMA <i>max. 4x0</i>	TC <i>max. 4x0</i>
165 mm	KOG-1	KAG-8
180 mm	KOG-2	KAG-9
200 mm	KOG-3	KAH-1
230 mm	KOG-4	KAH-2
260 mm	KOG-5	KAH-3
310 mm	KOG-6	KAH-4



MAYO-HEGAR

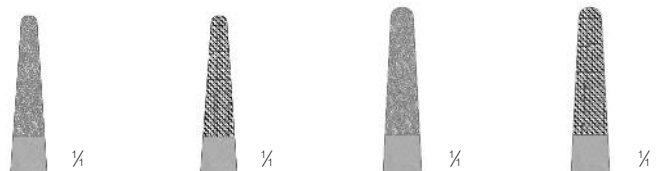

LENGTH LÄNGE	STANDARD		STRONG PATTERNS STARKE MODELLE	
	PLASMA <i>max. 2x0</i>	TC <i>max. 1x0</i>	PLASMA <i>max. 1x0</i>	TC <i>unlim.</i>
150 mm	KOF-1	KAP-4		
160 mm	KOF-2	KAP-5		
180 mm	KOF-3	KAP-6		KAL-0
200 mm	KOF-4	KAP-7	KOF-8	KAL-6
240 mm	KOF-5	KAP-8	KOF-9	KCP-5
260 mm	KOF-6	KAP-9		
300 mm	KOF-7	KAR-1		KCP-0



WANGENSTEEN

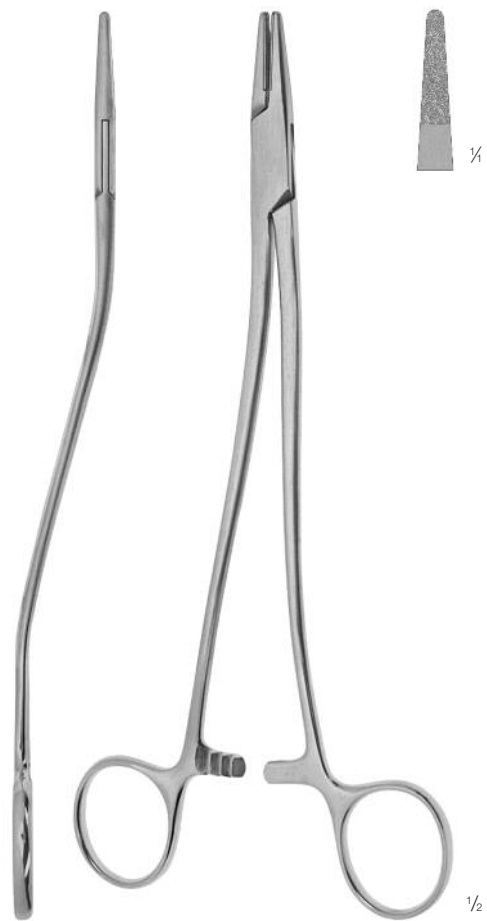

WERTHEIM

LENGTH LÄNGE	PLASMA <i>max. 2x0</i>	TC <i>max. 1x0</i>
240 mm	KOS-1	KAV-4
275 mm	KOS-2	KAV-5

LENGTH LÄNGE	PLASMA <i>max. 2x0</i>	TC <i>max. 1x0</i>
200 mm	KOS-3	KBG-1
240 mm	KOS-4	KBG-2
300 mm	KOS-5	KBG-0



TOENNIS
180 mm

PLASMA <i>max. 2x0</i>	TC <i>max. 2x0</i>
KOO-1	KAV-3



LANGENBECK-RYDER
200 mm

PLASMA <i>max. 5x0</i>	TC <i>max. 5x0</i>
KOO-2	KAL-8



LANGENBECK
200 mm

PLASMA <i>max. 2x0</i>	TC <i>max. 2x0</i>
KOO-3	KAM-1



MATHIEU

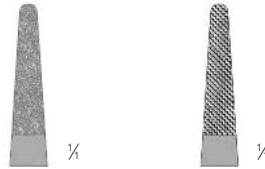

LENGTH LÄNGE	PLASMA <i>max. 2x0</i>	TC <i>max. 1x0</i>
140 mm	KOP-1	KAN-3
170 mm	KOP-2	KAN-4
200 mm	–	KAN-5



ZWEIFEL

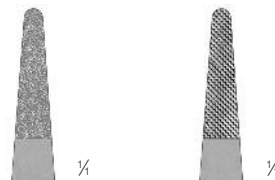

LENGTH LÄNGE	PLASMA <i>max. 2x0</i>	TC <i>max. 1x0</i>
200 mm	KOO-4	KAV-6
230 mm	KOO-5	KAV-7



STRATTE



HEANEY
200 mm

LENGTH LÄNGE	PLASMA <i>max. 2x0</i>	TC <i>max. 2x0</i>
210 mm	KON-6	KCE-9
230 mm	KON-7	KAU-9
270 mm	KON-8	KAV-1

PLASMA <i>max. 1x0</i>	TC <i>max. 1x0</i>
KOS-6	KAF-0



MASSON
265 mm

PLASMA <i>max. 1x0</i>	TC <i>max. 1x0</i>
KOS-7	KAM-7



FINOCHIETTO
265 mm

PLASMA <i>max. 4x0</i>	TC <i>max. 4x0</i>
KOS-8	KAK-4

PLEASE FIND MICRO NEEDLE HOLDERS IN CATALOGUE No. 1
MIKRONADELHALTER FINDEN SIE IN KATALOG Nr. 1

