

*FEHLING...*

*... THE DIFFERENCE*

10

BRAIN INSTRUMENTS  
HIRNCHIRURGISCHE  
INSTRUMENTE



**FEHLING**  
INSTRUMENTS

Hanauer Landstraße 7A · 63791 Karlstein/Germany · [www.fehling-instruments.de](http://www.fehling-instruments.de)

 +49 (0) 61 88 - 95 74.0

 +49 (0) 61 88 - 95 74.45

 [info@fehling-instruments.de](mailto:info@fehling-instruments.de)

CERAMO®

CRANIAL SET



HANDLES  
HANDGRIFFE

¼

¼

STRAIGHT  
GERADE

BAYONET  
BAJONETT

ABB-1

ABB-2



STERILISATION TRAY  
AUFBEWAHRUNGS- UND  
STERILISATIONSBEHÄLTER

210 x 180 mm





















210 x 230 mm

NUM-0

NVM-0













CERAMO®



CRANIAL SET		160 mm	210 mm
   1/4 ring curette / Ringkürette	2 mm	NUM-1	NVM-1
	4 mm	NUM-2	NVM-2
	6 mm	NUM-3	NVM-3
   1/4 ring curette / Ringkürette	2 mm	NUM-4	NVM-4
	4 mm	NUM-5	NVM-5
	6 mm	NUM-6	NVM-6
   1/4 ring curette / Ringkürette	2 mm	NUM-7	NVM-7
	4 mm	NUM-8	NVM-8
	6 mm	NUM-9	NVM-9
   1/4 ring curette / Ringkürette	2 mm	NUR-1	NVR-1
	4 mm	NUR-2	NVR-2
	6 mm	NUR-3	NVR-3
   1/4 ring curette / Ringkürette	2 mm	NUR-4	NVR-4
	4 mm	NUR-5	NVR-5
	6 mm	NUR-6	NVR-6
  1/4 dissector / Dissektor edged / scharf	1 mm	NUN-1	NVN-1
	2 mm	NUN-2	NVN-2
	3 mm	NUN-3	NVN-3
    1/4 dissector / Dissektor blunt / stumpf	1 mm	NUN-4	NVN-4
	1,5 mm	NUN-9	NVN-9
	2 mm	NUN-5	NVN-5
	3 mm	NUN-6	NVN-6
	4 mm	NUN-7	NVN-7









CERAMO®

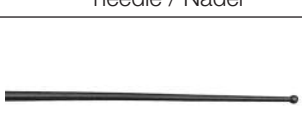
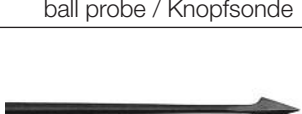

CRANIAL SET		160 mm	210 mm
 ¼ dissector / Dissektor blunt / stumpf	4 mm	NUN-8	NVN-8
 ¼	2 mm	NUO-1	NVO-1
 ¼	3 mm	NUO-2	NVO-2
 bone curette / scharfer Löffel	4 mm	NUO-3	NVO-3
 ¼	2 mm	NUO-4	NVO-4
 ¼ 45°	3 mm	NUO-5	NVO-5
 bone curette / scharfer Löffel	4 mm	NUO-6	NVO-6
 ¼ 45°	1 x 2 mm	NUT-4	NVT-4
 ¼ nerv hook / Nervhaken	1 x 4 mm	NUT-5	NVT-5
 ¼ 90° nerv hook / Nervhaken	1 x 2 mm	NUP-1	NVP-1
	1 x 3 mm	NUP-2	NVP-2
	1 x 4 mm	NUP-6	NVP-6
	1 x 5 mm	NUP-4	NVP-4
	1 x 8 mm	NUP-5	NVP-5
 ¼ 90° nerv hook / Nervhaken semi edged / halbscharf	0,4 x 2 mm	NUP-7	NVP-7
	0,4 x 3 mm	NUP-8	NVP-8
 ¼ 45° nerv hook / Nervhaken	1 x 3 mm	NUS-0	NVS-0
 ¼ 90° nerv hook / Nervhaken	1 x 3 mm	NUP-9	NVP-9
	1 x 5 mm	NUS-1	NVS-1
	1 x 8 mm	NUS-2	NVS-2



CERAMO®





CRANIAL SET		160 mm	210 mm
 1/4 nerv hook / Nervhaken	1 x 5 mm	NUS-3	NVS-3
 90° 1/4 nerv hook / Nervhaken pointed / spitz	3 mm	NUS-9	NVS-9
 1/4 needle / Nadel		NUS-8	NVS-8
 1/4 ball probe / Knopfsonde	1 mm	NUS-4	NVS-4
 1/4 lancet knife / Lanzettmesser		NUS-6	NVS-6
 1/4 sickle knife / Sichelmesser		NUS-7	NVS-7
 1/4 pulling knife / Zugmesser	3,5 mm	NUP-3	NVP-3
 1/4 disc knife / Tellermesser	4 mm	NUT-1	NVT-1
 1/4 45° disc knife / Tellermesser	2 mm	NUT-2	NVT-2
 1/4 disc knife / Tellermesser	4 mm	NUT-3	NVT-3
 1/4 micro knife / Mikromesser		NUT-6	-

CERAMO®



CRANIAL SET		160 mm
 ¼ 45°	2 mm	NUT-7
disc dissector / Tellerdissektor blunt / stumpf	4 mm	NUT-8
 ¼ LANKSCH nerve root retractor/ Nervwurzelhaken	3 mm	NUO-7
	5 mm	NUO-8
 ¼ tamper / Stößel	2 mm	NUX-1
	4 mm	NUX-2
	6 mm	NUX-3

POLYTOM KNIVES POLYTOM MESSER		160 mm
 ¼	4 mm	NUL-1
	5 mm	NUL-4
 ¼	4,5 mm	NUL-2

surface: amorphous carbon  
Oberfläche: amorpher Kohlenstoff

CERAMO®

RHOTON SET



TRAY / AUFBEWAHRUNGSBEHÄLTER













NBX-4

CERAMO®

RHOTON SET



190 mm















	1 mm	NTC-1
$\frac{1}{4}$ 	2 mm	NTC-2
dissector / Dissektor	3 mm	NTC-3
	1 mm	NTC-6
$\frac{1}{4}$ 	1,5 mm	NTC-7
dissector / Dissektor	2 mm	NTC-8
	1,2 mm	NTC-5
$\frac{1}{4}$ 	2,8 mm	NTC-4
elevator / Elevator		
	2 mm	NTC-9
$\frac{1}{4}$ hook / Häkchen semi-sharp / halbscharf		
	2 mm	NTD-1
$\frac{1}{4}$ hook / Häkchen blunt / stumpf		
	3 mm	NTD-2
$\frac{1}{4}$ hook / Häkchen semi-sharp / halbscharf		
		NTD-3
$\frac{1}{4}$ needle / Nadel semi-sharp / halbscharf		
	1 x 2 mm	NTD-4
$\frac{1}{4}$ bone curette / scharfer Löffel		
	1 x 2 mm	NTD-5
$\frac{1}{4}$ bone curette / scharfer Löffel		
		NTD-6
$\frac{1}{4}$ nerve hook / Nervhaken		

CERAMO®



260 mm  
a = 120 mm

MICRO INSTRUMENTS  
MIKROINSTRUMENTE

	0,5 mm	TOR-7
	1,0 mm	TOQ-1
	0,5 mm	TOR-8
	1,0 mm	TOQ-2
	2,0 mm	TOQ-3
	4,0 mm	TOQ-4
	2,0 mm	TOQ-5
	pointed spitz	TOR-1
	blunt stumpf	TOR-3
	pointed spitz	TOR-2
	blunt stumpf	TOR-4
	blunt stumpf	TOR-9
	pointed spitz	TOR-0
	0,5 mm	TOR-5
	0,5 mm	TOR-6

SHAFT ROTATABLE  
SCHAFT DREHBAR

CERAMO®

CLIP APPLYING FORCEPS  
CLIPANLEGEZANGEN



FOR / FÜR YASARGIL  
+ SUGITA CLIPS



		CLIP ROTATABLE / DREHBAR	
			
TOTAL LENGTH GESAMTLÄNGE		230 mm	270 mm
LENGTH a LÄNGE a		80 mm	120 mm
CLIP SIZE CLIP GRÖßE	MINI	TOQ-9	TOQ-7
	STANDARD	TOQ-8	TOQ-6

SHAFT ROTATABLE  
SCHAFT DREHBAR

SUPERPLAST

FOR / FÜR YASARGIL + SUGITA CLIPS



		CLIP FIXED / STARR			CLIP ROTATABLE / DREHBAR		
							
LENGTH a LÄNGE a		70 mm	90 mm	110 mm	70 mm	90 mm	110 mm
CLIP SIZE CLIP GRÖßE	MINI	NIB-1	NIB-2	NIB-3	NIB-7	NIB-8	NIB-9
	STANDARD	NIC-0	NIC-1	NIB-0	NIB-4	NIB-5	NIB-6

SUPERPLAST SHAFT / SCHAFT

SUPERPLAST Instruments are constructed of shapememory metal. They are malleable in normal O.R. temperatures. Soft pressure allows "permanent" deformation of shape according to the surgeon's needs. However in higher temperatures, such as those found in the autoclave, the instruments regain their initial shape.

SUPERPLAST Instrumente sind aus Metall mit Formgedächtnis. Sie sind bei normaler OP-Temperatur biegsam. Sie können durch sanften Druck in die gewünschte Form gebracht werden. Unter höheren Temperaturen, wie bei der Sterilisation, nehmen sie ihre ursprüngliche Form wieder an.

CERAMO®

NICOLA



SCISSORS  
SCHEREN

	straight / gerade	up / aufwärts	down / abwärts	left / links	right / rechts
160 mm	NOJ-1	NOJ-2	NOJ-3	NOJ-4	NOJ-5
	NBR- 9	-	-	-	-
200 mm	NTF-1	NTF-4	NTF-5	NTF-3	NTF-2
	TOM-6	-	-	TOM-8	TOM-7
	NBS-1	NBS-2	NBS-3	NBS-5	NBS-4
250 mm	NOL-7			NOL-8	NOL-9



GRASPING FORCEPS  
FASSZANGEN

	straight / gerade	up / aufwärts	down / abwärts	left / links	right / rechts
160 mm	NOJ-6	NOJ-7	NOJ-8	NOJ-9	NOK-0
	NBR- 3	-	-	-	-
200 mm	NTF-6	NTF-7	NTF-8	NTF-9	NTG-0
	TOM-1	-	-	-	-
	NBR-4	NBR-5	NBR-6	NBR-7	NBR-8
250 mm	NOK-8	-	-	-	-

 TITANIUM / TITAN

 UNCOATED / UNBESCHICHTET

CERAMO®

DURASCISSORS  
DURASCHERE



CERAMO® TITANIUM

BRAIN SPATULAS / HIRNSPATEL  
MALLEABLE / BIEGBAR

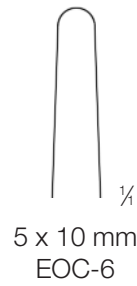
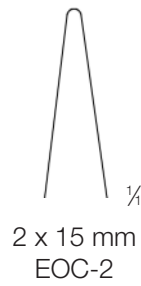
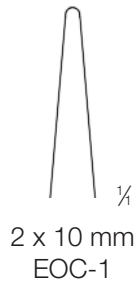

12 mm

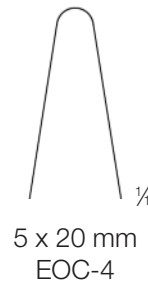
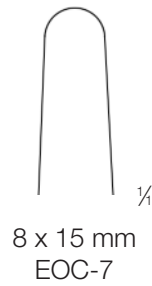
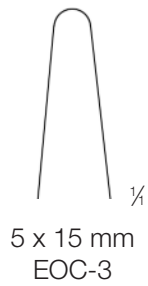
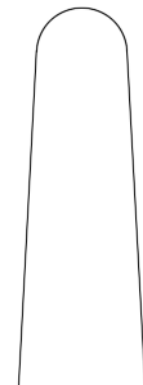

20 mm  
EOC-8

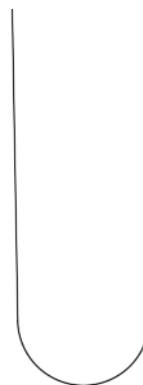

1/4

CERAMO® SUPERPLAST

BRAIN SPATULAS / HIRNSPATEL  
MALLEABLE / BIEGBAR



180 mm  $\frac{1}{2}$

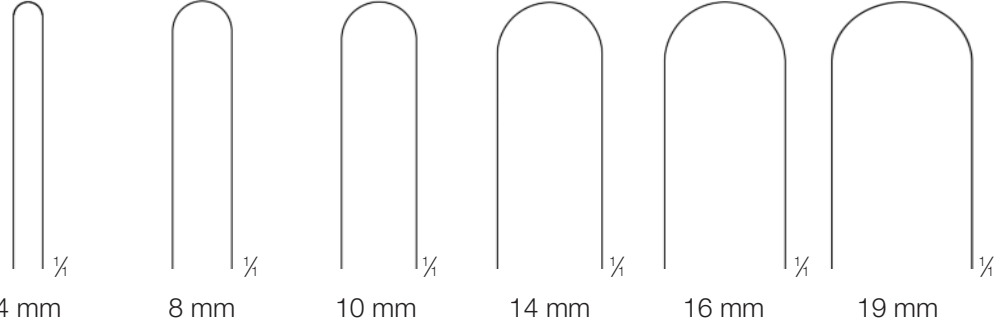

STANDARD	EOI-1	EOI-2	EOI-3	EOI-4	EOI-5	EOI-9
STRONG STARK	EOI-6	EOI-7	EOI-8	EOK-9	-	-

SUPERPLAST Instruments are constructed of shapememory metal. They are malleable in normal O.R. temperatures. Soft pressure allows "permanent" deformation of shape according to the surgeon's needs. However in higher temperatures, such as those found in the autoclave, the instruments regain their initial shape.

SUPERPLAST Instrumente sind aus Metall mit Formgedächtnis. Sie sind bei normaler OP-Temperatur biegsam. Sie können durch sanften Druck in die gewünschte Form gebracht werden. Unter höheren Temperaturen, wie bei der Sterilisation, nehmen sie ihre ursprüngliche Form wieder an.



180 mm  $\frac{1}{2}$

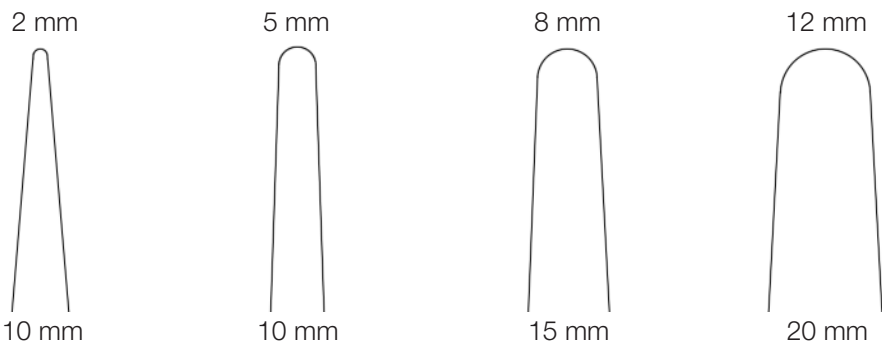

STANDARD	EOK-1	EOK-2	EOK-3	EOK-4
STRONG STARK	EOK-5	EOK-8	EOK-7	-

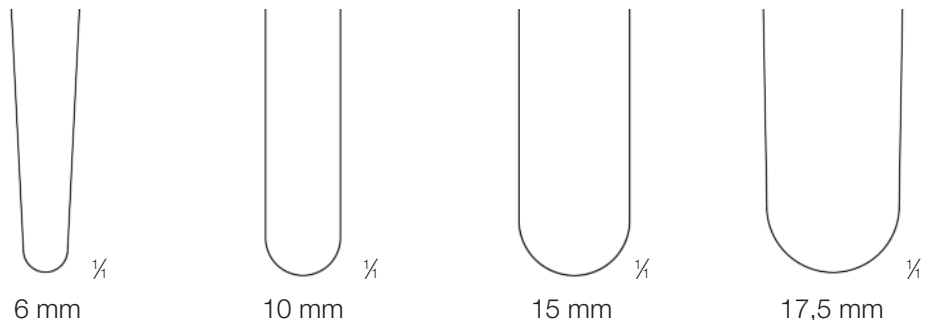

CERAMO® SUPERPLAST

BRAIN SPATULAS / HIRNSPATEL  
MALLEABLE / BIEGBAR

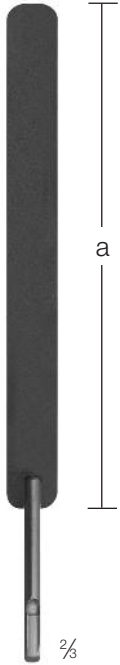

130 mm  
a = 100 mm

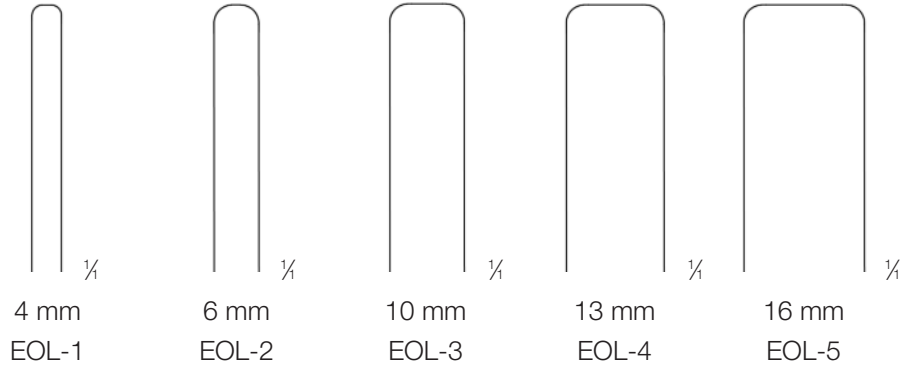

SUPERPLAST Instruments are constructed of shapememory metal. They are malleable in normal O.R. temperatures. Soft pressure allows "permanent" deformation of shape according to the surgeon's needs. However in higher temperatures, such as those found in the autoclave, the instruments regain their initial shape.

SUPERPLAST Instrumente sind aus Metall mit Formgedächtnis. Sie sind bei normaler OP-Temperatur biegsam. Sie können durch sanften Druck in die gewünschte Form gebracht werden. Unter höheren Temperaturen, wie bei der Sterilisation, nehmen sie ihre ursprüngliche Form wieder an.



130 mm  
a = 100 mm

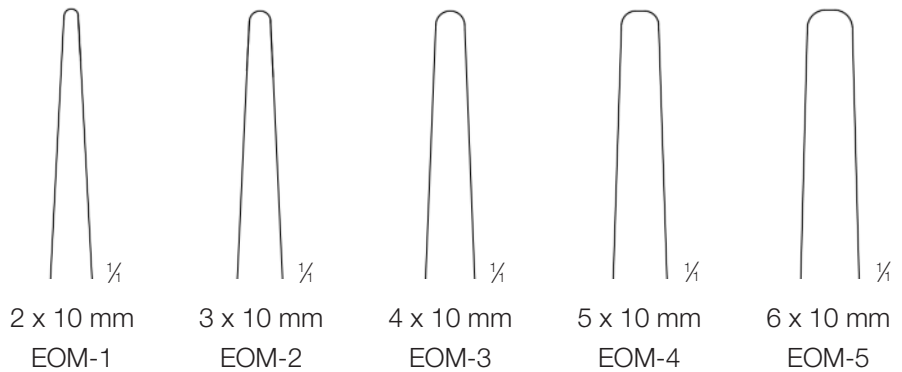

Shafts suitable for all common head rest systems.  
Die Schäfte passen in alle gängigen Kopfhaltssysteme.

SPECULA



CERAMO®  
PITUITARY SPECULUM  
HYPOPHYSENSPEKULUM

70 x 10 mm	NVK-7
	NVL-7
80 x 10 mm	NVK-8
	NVL-8
70 x 15 mm	NVG-1
	NVL-1
80 x 15 mm	NVG-2
	NVL-2
90 x 15 mm	NVG-3
	NVL-3
100 x 15 mm	NVG-4
	NVL-4
110 x 15 mm	NVG-5
	NVL-5

 TITANIUM / TITAN



with locking screw  
mit Stellschraube

KILLIAN  
NASAL SPECULUM  
NASENSPEKULUM



KILLIAN  
NASAL SPECULUM  
NASENSPEKULUM

37 x 7 mm	OAT-9
52 x 7 mm	OAU-1
75 x 7 mm	OAU-2

36 x 7 mm	OAT-5
56 x 7 mm	OAT-6
75 x 7 mm	OAT-7
90 x 7 mm	OAT-8

PERNECZKY TITANIUM  
BRAIN RETRACTOR  
HIRNSPREIZER

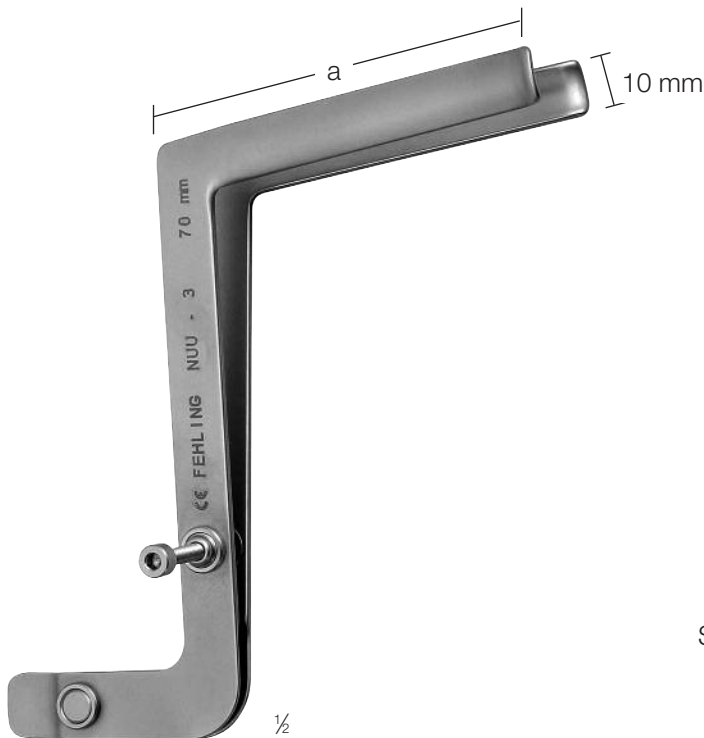

SUPPORT FOR LEYLA-RETRACTOR  
SPATELHALTER FÜR LEYLA-RETRAKTOR

NEA-2

DEPTH a TIEFE a	
50 mm	NUU-1
60 mm	NUU-2
70 mm	NUU-3
80 mm	NUU-4
90 mm	NUU-5
100 mm	NUU-6



exemplary configuration  
Konfigurationsbeispiel